

# VL4

## Installation Guide for 701269-(XX)3A1-MB, 701269-(XX)2A1-MB, 701269-(XX)1A1-MB

**WARNING:** Risk of electrical shock. New installation and LED Retrofit Kit installation requires knowledge of sign electrical systems. If not qualified, do not attempt installation. Contact a qualified electrician. Follow all NEC and local codes. VL4 is not suitable for submersion or direct exposure to water for extended periods of time. **AVERTISSEMENT:** Risque de choc électrique. La nouvelle installation et l'installation du kit de modification à LED nécessitent la connaissance des systèmes électriques de signalisation. Si non qualifié, ne tentez pas l'installation. Contactez un électricien qualifié. Suivez tous les codes NEC et locaux. VL4 ne convient pas à la submersion ni à l'exposition directe à l'eau pendant de longues périodes.

**For New Installation, proceed with Step 1 below. For Retrofit Installations, begin with Retrofit Instructions on page 2.**

### New Installation

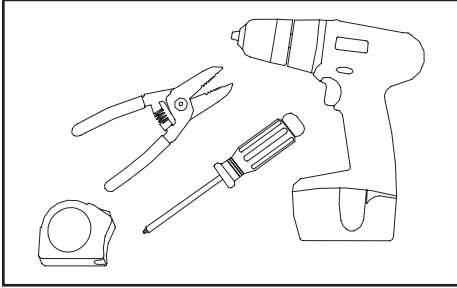

1. **Tools required:** Measuring tape, wire strippers. **Optional:** Drill, screwdriver.

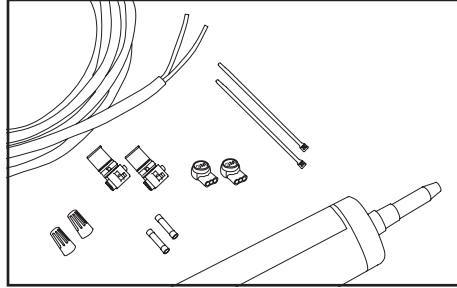

**NOTE:** Modules must be mounted in an enclosed sign. This product is not suitable for immersion or direct exposure to water for extended periods of time.

**REMARQUE:** Les modules doivent être montés dans un panneau fermé. Ce produit ne convient pas à une immersion ou à une exposition directe à l'eau pendant de longues périodes.

#### 2. Components list:

- VL4 modules, model numbers 701269-(XX)3A1-MB, 701269-(XX)2A1-MB, 701269-(XX)1A1-MB
- SloanLED 12 V Class 2 output power supply (refer to "12 VDC Power Supply Capacity Chart" for appropriate model numbers)
- UL approved 18 AWG or larger diameter supply wire
- UL approved wire connectors appropriate for wire gauge used
- Optional for mounting: Electrical grade silicone, #6 (M3) sheet metal screws, or 1/8" (3 mm) aluminum rivets

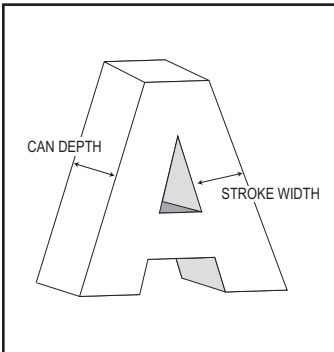

3. **Layout:** To populate sign, refer to VL4 density guidelines as well as power supply loading chart below to determine appropriate number of modules and power supplies.

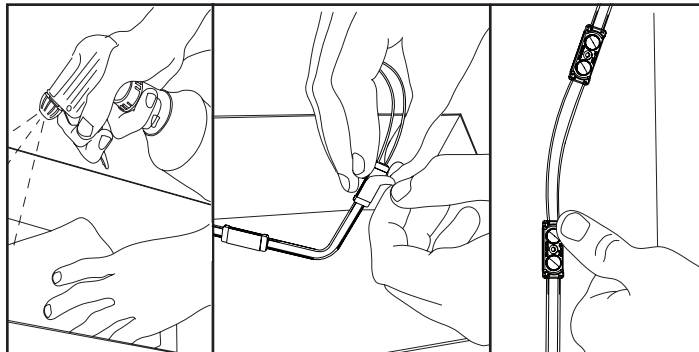

4. **Peel and stick:** Clean inside sign with rubbing alcohol and allow to dry. Using predetermined layout and LED placement from Step 3, remove tape backing and stick modules into place. Ensure modules are firmly attached.

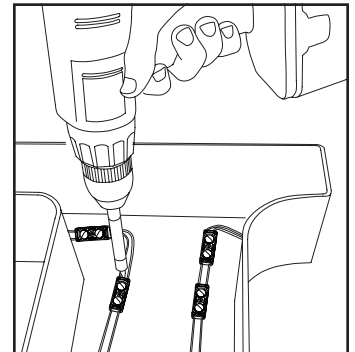

5. **Fasteners:** If desired, modules can be secured with #6 (3.5 mm) pan head sheet metal screws.

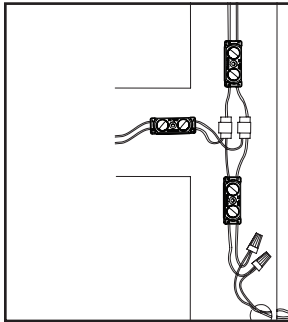

**WARNING:** Connect Red striped wire of LED modules (+) to Red wire of power supply (+). Connect White wire of LED modules (-) to Black wire of power supply (-). Reverse polarity connections may damage LEDs and will void product warranty. **AVERTISSEMENT:** Connectez le fil rayé rouge des modules LED (+) au fil rouge de l'alimentation (+). Connectez le fil blanc des modules LED (-) au fil noir de l'alimentation (-). Des connexions inversées peuvent endommager les LEDs et annuler la garantie du produit.

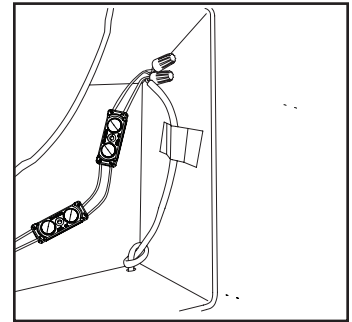
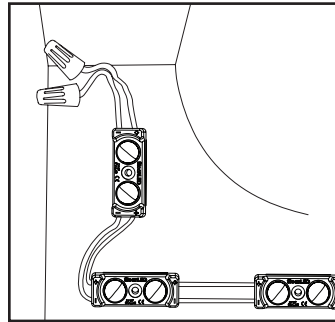

6. **Connections:** Modules may be connected in series or parallel.

7. **Cap all unused wires:** Strand of modules should not be looped to create a closed circuit.

8. **Connect power supply to first module on string:** See power supply install guide for more information regarding power supply installation.

## Retrofit Instructions for Existing Signs



GENERAL PURPOSE  
RETROFIT SIGN CONVERSION.  
FOR USE ONLY IN ACCORDANCE  
WITH KIT INSTRUCTIONS.

KIT IS COMPLETE ONLY WHEN ALL PARTS  
REQUIRED BY THE INSTRUCTIONS ARE PRESENT.

**WARNING:** Risk of fire or electric shock. Install this kit only in host signs that have been identified in the installation instructions, and where the input rating of the retrofit kit does not exceed the input rating of the sign. Installation of this LED retrofit kit may involve drilling or punching of holes into the structure of the sign. Check for enclosed wiring and components to avoid damage to wiring and electrical parts. **AVERTISSEMENT:** Risque d'incendie ou de choc électrique. Installez ce kit uniquement sur les panneaux hôtes identifiés dans les instructions d'installation et dans lesquels les caractéristiques nominales d'entrée du kit de modification ne dépassent pas celles du panneau. L'installation de ce kit d'amélioration des LED peut impliquer de percer ou de percer des trous dans la structure de l'enseigne. Vérifiez le câblage et les composants inclus pour éviter d'endommager le câblage et les pièces électriques.

1. Identify sign to be retrofit and ensure branch circuit supplying existing sign are within voltage range for LED power supply. Refer to components list (page 1) and "12 VDC Power Supply Capacity Chart" (page 3).
2. Remove existing lighting equipment intended to be replaced, such as neon or fluorescent, and all power supplies, transformers, or ballasts. Remove existing neon and all standoffs to leave an empty channel letter can. **NOTE:** All materials removed must be disposed of in accordance with applicable local, state, and federal laws.
3. If required by local, state, or national electrical code, install a new disconnect switch.
4. Determine suitability and structural integrity of existing sign after removal of existing lighting equipment. If retrofit does not require the making of any new holes, do not make or alter any open holes in an enclosure of wiring or electrical components during kit installation. If existing holes are present in a wet or outdoor location sign, repair and seal any unused openings in the electrical enclosure. Openings greater than 0.5" (12.7 mm) diameter require a metal patch secured by screws or rivets and caulked with non-hardening caulk. Smaller openings may be sealed with non-hardening caulk.
5. Clean inside of sign using non-oil based cleaner. Follow all manufacturer's instructions and ensure inside of sign is dry before proceeding with installation. This is an important step for good adhesion of SloanLED channel letter module mounting tape.
6. To populate sign, refer to VL4 density guidelines as well as power supply loading chart to determine appropriate number of modules and power supplies. A list of acceptable power supply models is shown in the "12 VDC Power Supply Capacity Chart" (page 3).
7. Follow all instructions on page 1 under "New Installation" to properly install LED modules.
8. Connect modules to power supply output as shown on page 1 under "New Installation".
9. Connect power supply input as outlined in power supply installation guide in accordance with local, state and national electrical codes by qualified personnel. Refer to power supply install guide included with power supply for details.
10. If required, install disconnect switch in accordance with local, state and national electrical codes by qualified personnel.

# VL4

## Installation Guide for 701269-(XX)3A1-MB, 701269-(XX)2A1-MB, 701269-(XX)1A1-MB

### 12 VDC Power Supply Capacity Chart

Power supply	Part number	Retrofit certified	Input				Output				Maximum feet (meters) / modules			
			Nominal input voltage	Input current	Power output	Output current	VL4			VL4 Mini		VL4 HO		
							White 7200 K, 6500 K (1.4/ft, 4.6/m)	Red, Green, Blue (1.5/ft, 4.9/m)	White 6500 K, 5000 K, 3000 K (2.5/ft, 8.2/m)	White 6500 K (1.5/ft, 4.9/m)				
Self-Contained 20 W	701680	●	100-240 V	0.55 A	20 W	1.67 A	13.6 (4.1) / 19 mods	24.0 (7.3) / 36 mods	20 (6.1) / 50 mods	10.0 (3.0) / 15 mods				
Compact 12/25 W*	410174		100-277 V	0.40 A	25 W	1.9 A	16.4 (5.0) / 23 mods	30.0 (9.1) / 45 mods	24.8 (7.6) / 62 mods	12.7 (3.9) / 19 mods				
60C1 60 W	701507-60C1	●	100-277 V	0.70 A	60 W	5.0 A	40.0 (12.2) / 56 mods	72.0 (21.9) / 108 mods	60.0 (18.3) / 150 mods	30.0 (9.1) / 45 mods				
60C2 60 W	701507-60C2	●	100-277 V	0.80 A										
60W2(E) 60 W	701507-60W2(E)	●	100-277 V	0.70 A										
60W3 60 W	701507-60W3	●	100-277 V	0.80 A										
120D1 120 W	701507-120D1	●	100-277 V	1.70 A	2 × 60 W	2 × 5.0 A	2 × 40.0 (12.2) / 56 mods	2 × 72.0 (21.9) / 108 mods	2 × 60.0 (18.3) / 150 mods	2 × 30.0 (9.1) / 45 mods				
Capacities based on 90% of power supply output.			Power used per foot (meter) in watts				1.34 W (4.41)	0.75 W (2.46)	0.90 W (2.95)	1.80 W (5.91)				

\* For sign applications, only certified for use outside of U.S. and Canada.

**NOTE:** Each 12 V circuit must be limited to 5 A (60 W) or less. For North American installations, a power supply that meets NEC Class 2 specifications is required.

### Extension of Power Supply Leads

If longer lead wire from power supply to LED modules is needed, an extension can be used. Extension should be kept as short as possible, i.e., under 15 ft for 18 AWG UL Listed PLTC (4.6 m for 1 mm<sup>2</sup> PLTC) or under 50 ft for 14 AWG UL Listed PLTC (15.2 m for 2.5 mm<sup>2</sup> PLTC).

### Troubleshooting

NOTE: A licensed electrician should perform all applicable steps. REMARQUE: Un électricien agréé doit effectuer toutes les étapes applicables.	
Entire sign or leg does not light after complete installation	Check connection from power supply lead to first module. Make sure polarity of connections made at the power supply lead and any jumper wire is correct. Power supply outputs should be connected RED-TO-RED and BLACK-TO-WHITE.
Still does not light	Check output voltage of power supply using a voltmeter. The output voltage should be DC 12.0 V ± 0.5 V. If there is no output voltage, have a licensed electrician check input voltage. Make sure power supply is connected correctly and getting primary power. If power supply is connected properly and getting primary power and there is still no output voltage, try a different power supply.
Still does not light	If power supply is getting primary power and the modules don't light, there may be a short in the secondary wiring. Check all connections and cap all loose wires.
The beginning of a leg lights, but the entire leg does not light or lights intermittently	The primary cause of a portion of a VL4 leg not lighting or lighting intermittently is a bad connection or reverse polarity connection between the modules that light and the modules that don't light. Check this connection.



Customer service and technical support  
888.747.4LED (888.747.4533)  
SloanLED.com • info@SloanLED.com

Europe: Customer service and technical support  
+31 88 12 44 900  
SloanLED.com • Europe@SloanLED.com

