

BackLED M Plus G4

LED modules for light advertising and backlighting



Areas of application

- Backlighting of medium size channel letters
- Backlighting of medium light boxes

Product family benefits

- Good uniformity and less module density thanks to unique Square Optical Lens design
- Consistent white light (Standard Deviation of Color Matching SDCM: < 3)
- Color rendering index R_a : 80
- Completely molded housing protects PCB and LEDs
- Easier pre-mounting with double-sided tape with extra long foil



Product family datasheet

Technical data

Electrical data

Product description	Nominal voltage	Nominal wattage per chain	Nominal wattage per LED module	Accidental reverse input voltage protection up to	Input voltage range	Type of current
BA-M-CP-880 G4	12.0 V	28.80 W	0.72 W	13 V	12...13 V	DC
BA-M-CP-865 G4	12.0 V	28.80 W	0.72 W	13 V	12...13 V	DC
BA-M-CP-840 G4	12.0 V	28.80 W	0.72 W	13 V	12...13 V	DC
BA-M-CP-830 G4	12.0 V	28.80 W	0.72 W	13 V	12...13 V	DC
BA-M-CP-RED G4	12.0 V	24.00 W	0.6 W	13 V	12...13 V	DC
BA-M-CP-BLUE G4	12.0 V	24.00 W	0.6 W	13 V	12...13 V	DC

Photometrical data

Product description	Color temperature	Color rendering index Ra	Light color (designation)	Light color LED	Luminous flux per module chain	Luminous flux per LED module
BA-M-CP-880 G4	8000 K	≥80	Cool White	Cool white	3080 lm	77 lm
BA-M-CP-865 G4	6500 K	≥80	Cool White	Cool white	3080 lm	77 lm
BA-M-CP-840 G4	4000 K	≥80	Neutral White	Neutral white	3080 lm	77 lm
BA-M-CP-830 G4	3000 K	≥80	Warm White	Warm white	3080 lm	73 lm
BA-M-CP-RED G4			Red	Red	820 lm	21 lm
BA-M-CP-BLUE G4			Blue	Blue	352 lm	9 lm

Product description	Luminous efficacy
BA-M-CP-880 G4	107 lm/W
BA-M-CP-865 G4	107 lm/W
BA-M-CP-840 G4	107 lm/W
BA-M-CP-830 G4	101 lm/W
BA-M-CP-RED G4	35 lm/W
BA-M-CP-BLUE G4	15 lm/W

Product family datasheet

Light technical data

Product description	Beam angle
BA-M-CP-880 G4	155 °
BA-M-CP-865 G4	155 °
BA-M-CP-840 G4	155 °
BA-M-CP-830 G4	155 °
BA-M-CP-RED G4	155 °
BA-M-CP-BLUE G4	155 °

LED module information

Product description	Number of LEDs per module	Number of LED modules per chain	Minimum operable number of LED modules
BA-M-CP-880 G4	3	40	40
BA-M-CP-865 G4	3	40	40
BA-M-CP-840 G4	3	40	40
BA-M-CP-830 G4	3	40	40
BA-M-CP-RED G4	3	40	40
BA-M-CP-BLUE G4	3	40	40

Dimensions & weight

Product description	Length	Width	Height	Product weight
BA-M-CP-880 G4	47.5 mm	13.8 mm	6.8 mm	270.00 g
BA-M-CP-865 G4	47.5 mm	13.8 mm	6.8 mm	270.00 g
BA-M-CP-840 G4	47.5 mm	13.8 mm	6.8 mm	270.00 g
BA-M-CP-830 G4	47.5 mm	13.8 mm	6.8 mm	270.00 g
BA-M-CP-RED G4	47.5 mm	13.8 mm	6.8 mm	270.00 g
BA-M-CP-BLUE G4	47.5 mm	13.8 mm	6.8 mm	270.00 g

Product family datasheet

Product line drawing

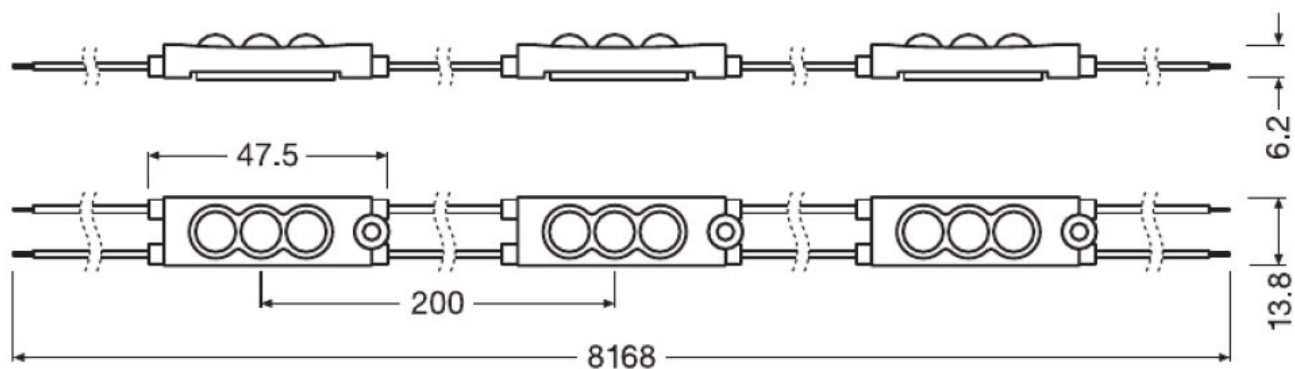

BA-M-CP-880 G4, BA-M-CP-865 G4, BA-M-CP-840 G4, BA-M-CP-830 G4, BA-M-CP-RED G4, BA-M-CP-BLUE G4

Temperatures & operating conditions

Product description	Temperature range in operation at T _c point	Temperature range at storage
BA-M-CP-880 G4	-30...70 °C ¹⁾	-30...85 °C
BA-M-CP-865 G4	-30...70 °C ¹⁾	-30...85 °C
BA-M-CP-840 G4	-30...70 °C ¹⁾	-30...85 °C
BA-M-CP-830 G4	-30...70 °C ¹⁾	-30...85 °C
BA-M-CP-RED G4	-30...70 °C ¹⁾	-30...85 °C
BA-M-CP-BLUE G4	-30...70 °C ¹⁾	-30...85 °C

¹⁾ Exceeding the maximum ratings will reduce expected life time or destroy the LED strip. / At the T_c point

Product family datasheet

Lifespan

Product description	Lifespan
BA-M-CP-880 G4	50000 h ¹⁾
BA-M-CP-865 G4	50000 h ¹⁾
BA-M-CP-840 G4	50000 h ¹⁾
BA-M-CP-830 G4	50000 h ¹⁾
BA-M-CP-RED G4	50000 h ¹⁾
BA-M-CP-BLUE G4	50000 h ¹⁾

¹⁾ L70/B50

Capabilities

Product description	Dimmable	Dimming range
BA-M-CP-880 G4	Yes	1...100 %
BA-M-CP-865 G4	Yes	1...100 %
BA-M-CP-840 G4	Yes	1...100 %
BA-M-CP-830 G4	Yes	1...100 %
BA-M-CP-RED G4	Yes	1...100 %
BA-M-CP-BLUE G4	Yes	1...100 %

Certificates & standards

Product description	Energy consumption	Energy efficiency class	Type of protection
BA-M-CP-880 G4	29 kWh/1000h	A+	IP66
BA-M-CP-865 G4	29 kWh/1000h	A+	IP66
BA-M-CP-840 G4	29 kWh/1000h	A+	IP66
BA-M-CP-830 G4	29 kWh/1000h	A+	IP66
BA-M-CP-RED G4	24 kWh/1000h	B	IP66
BA-M-CP-BLUE G4	24 kWh/1000h	C	IP66

Product description	Standards
BA-M-CP-880 G4	Acc. to IEC 62471/Acc. to IEC 61347-1/Acc. to EN 62031/Acc. to IEC 60598-1/Acc. to EN 55015/Acc. to EN 61547/Acc. to IEC 62778
BA-M-CP-865 G4	Acc. to IEC 62471/Acc. to IEC 61347-1/Acc. to EN 62031/Acc. to IEC 60598-1/Acc. to EN 55015/Acc. to EN 61547/Acc. to IEC 62778
BA-M-CP-840 G4	Acc. to IEC 62471/Acc. to IEC 61347-1/Acc. to EN 62031/Acc. to IEC 60598-1/Acc. to EN 55015/Acc. to EN 61547/Acc. to IEC 62778
BA-M-CP-830 G4	Acc. to IEC 62471/Acc. to IEC 61347-1/Acc. to EN 62031/Acc. to IEC 60598-1/Acc. to EN 55015/Acc. to EN 61547/Acc. to IEC 62778

Product family datasheet

Product description	Standards
BA-M-CP-RED G4	Acc. to IEC 62471/Acc. to IEC 61347-1/Acc. to EN 62031/Acc. to IEC 60598-1/Acc. to EN 55015/Acc. to EN 61547/Acc. to IEC 62778
BA-M-CP-BLUE G4	Acc. to IEC 62471/Acc. to IEC 61347-1/Acc. to EN 62031/Acc. to IEC 60598-1/Acc. to EN 55015/Acc. to EN 61547/Acc. to IEC 62778

Logistical data

Product description	Commodity code
BA-M-CP-880 G4	940540399000
BA-M-CP-865 G4	940540399000
BA-M-CP-840 G4	940540399000
BA-M-CP-830 G4	940540399000
BA-M-CP-RED G4	940540399000
BA-M-CP-BLUE G4	940540399000







Application advice

For more detailed application information and graphics please see product datasheet.

Sales and Technical Support

Sales and Technical Support www.osram.com

Download Data

File
 IES data IES file of BA-M-CP-880 G4
 IES data IES file of BA-M-CP-865 G4
 IES data IES file of BA-M-CP-840 G4
 IES data IES file of BA-M-CP-830 G4
 IES data IES file of BA-M-CP-RED
 IES data IES file of BA-M-CP-Blue

Logistical Data

Product family datasheet

Product code	Product description	Packaging unit (Pieces/Unit)	Dimensions (length x width x height)	Volume	Gross weight
4052899592971	BA-M-CP-880 G4	Shipping carton box 50	435 mm x 435 mm x 310 mm	58.66 dm ³	15282.00 g
4052899592995	BA-M-CP-865 G4	Shipping carton box 50	435 mm x 435 mm x 310 mm	58.66 dm ³	15282.00 g
4052899593022	BA-M-CP-840 G4	Shipping carton box 50	435 mm x 435 mm x 310 mm	58.66 dm ³	15282.00 g
4052899593053	BA-M-CP-830 G4	Shipping carton box 50	435 mm x 435 mm x 310 mm	58.66 dm ³	15282.00 g
4052899593084	BA-M-CP-RED G4	Shipping carton box 50	435 mm x 435 mm x 310 mm	58.66 dm ³	15282.00 g
4052899593114	BA-M-CP-BLUE G4	Shipping carton box 50	435 mm x 435 mm x 310 mm	58.66 dm ³	15282.00 g

The mentioned product code describes the smallest quantity unit which can be ordered. One shipping unit can contain one or more single products. When placing an order, for the quantity please enter single or multiples of a shipping unit.

Disclaimer

Subject to change without notice. Errors and omission excepted. Always make sure to use the most recent release.