

# Ellips / Quattro / Ringo

## NL Bewegwijzering systemen Specificaties

<b>Sign systeem:</b>	Ellips, Quattro & Ringo
<b>Kenmerk:</b>	Profielen & onderdelen voor wegwijzers
<b>Profielen:</b>	6100 mm, EN AW 6060-T6, brute, geanodiseerd & RAL 9010
<b>Medium:</b>	Borden of ACP platen
<b>Gebruik:</b>	Binnen & buiten
<b>Onderdelen:</b>	Eindkappen & ronde hoeken

## EN Signposting Specifications

<b>Sign system:</b>	Ellips, Quattro & Ringo
<b>Features:</b>	Profiles & parts for signposting systems
<b>Profiles:</b>	6100 mm, EN AW 6060-T6, mill finish, anodised & RAL 9010
<b>Medium:</b>	Signposting panels & ACP panels
<b>Usage:</b>	Indoor & outdoor
<b>Parts:</b>	End caps & round cornerpieces

## DE Ausschilderung Spezifikationen

<b>Sign System:</b>	Ellips, Quattro & Ringo
<b>Eigenschaften:</b>	Profile & Zubehör für Hinweissysteme
<b>Profil:</b>	6100 mm, EN AW 6060-T6, erhältlich in roh, eloxiert oder in RAL 9010
<b>Medium:</b>	Schilder & ACM-Kompositplatten
<b>Anwendung:</b>	für den Innen- & Außenbereich
<b>Zubehör:</b>	Endstück & rundes Eckstück



## Ellips

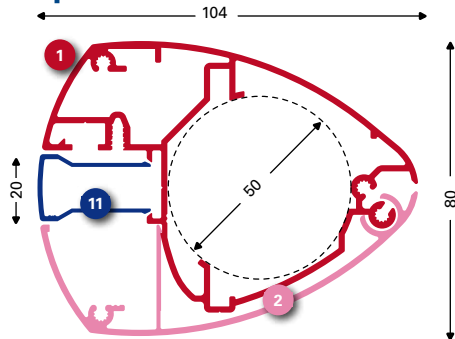

- 1** 133010 (133015\* 133011\*\*) Ellips Staander brute  
Ellips Stand profile mill  
Ellips Ständer roh
- 2** 133020 (133025\* 133021\*\*) Ellips Afdeklijst brute  
Ellips Cover mill  
Ellips Abdeckleiste roh
- 3** 133065 (133067\* 133066\*\*) Ellips Eindkap brute  
Ellips End cap mill  
Ellips Endstück roh
- 11** 133030 (133035\* 133032\*\*) Klikprofiel brute  
Click profile mill  
Schnappleiste roh



## Quattro

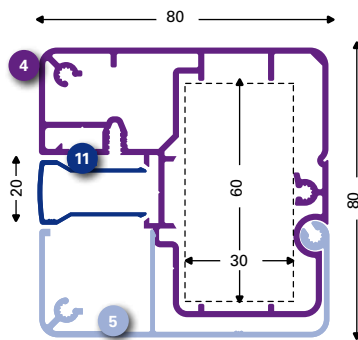

- 4** 133080 (133082\* 133083\*\*) Quattro Staander brute  
Quattro Stand profile mill  
Quattro Ständer roh
- 5** 133085 (133087\* 133088\*\*) Quattro Afdeklijst brute  
Quattro Cover mill  
Quattro Abdeckleiste roh
- 6** 133095 (133096\* 133097\*\*) Quattro Eindkap brute  
Quattro End cap mill  
Quattro Endstück roh
- 11** 133030 (133035\* 133032\*\*) Klikprofiel brute  
Click profile mill  
Schnappleiste roh

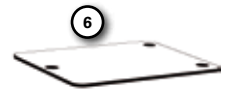

## Ringo

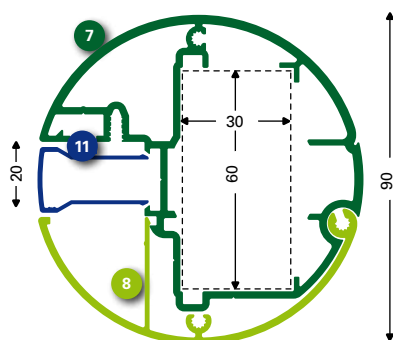

- 7** 133510 (133515\* 133512\*\*) Ringo Staander brute  
Ringo Stand profile mill  
Ringo Ständer roh
- 8** 133520 (133525\* 133522\*\*) Ringo Afdeklijst brute  
Ringo Cover mill  
Ringo Abdeckleiste roh
- 9** 133535 (133537\* 133536\*\*) Ringo Eindkap brute  
Ringo End cap mill  
Ringo Endstück roh
- 10** 133560 Ringo Hoekstuk rond brute  
Ringo Cornerpiece round mill  
Ringo Eckstück rund roh
- 11** 133030 (133035\* 133032\*\*) Klikprofiel brute  
Click profile mill  
Schnappleiste roh

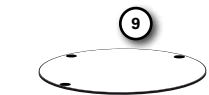

\* RAL  
\*\* Geanodiseerd

\* RAL  
\*\* Anodised

\* RAL  
\*\* Eloxiert

# Ellips / Quattro / Ringo

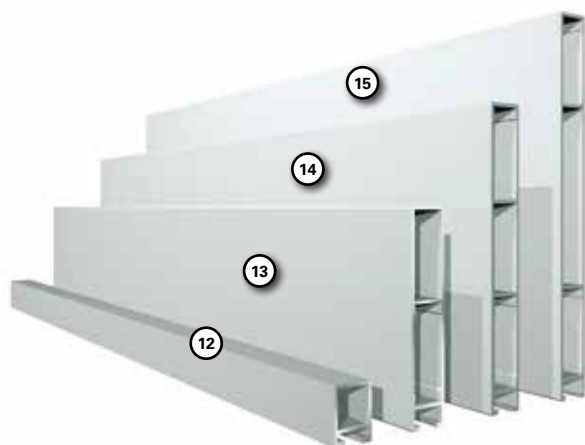

- 12 **133100 (133101\*)**  
Omrandingsprofiel 9 mm brute  
Border profile 9 mm mill  
Umrandungsprofil 9 mm roh

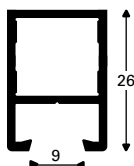

## Omrandingsprofiel / Border profile / Umrandungsprofil

Het omrandingsprofiel kan worden gebruikt om panelen met dikte van 8-9 mm te omranden en in Ellips/Quattro/Ringo toe te passen. Hiermee is het mogelijk om in één keer grote beletterde panelen te gebruiken.

The border profile can be used to apply borders to 8-9 mm panels in Ellips/Quattro/Ringo. This enables large lettered panels to be applied in one go.

Das Umrandungsprofil kann dazu verwendet werden, Schilder mit Dicke 8-9 mm zu umranden und im Ellips/Quattro/Ringo zu integrieren. So können mehrere große beschriftete Schilder untereinander montiert werden.



## Ellips & SlimLine

\*RAL 9010  
\*\*Geanodiseerd

\*RAL 9010  
\*\*Anodised

\*RAL 9010  
\*\*Eloxiert

- 13 **133040 (133045\* 133041\*\*)**  
Bord 100 mm brute  
Panel 100 mm mill  
Schild 100 mm roh
- 14 **133050 (133055\* 133051\*\*)**  
Bord 150 mm brute  
Panel 150 mm mill  
Schild 150 mm roh
- 15 **133060 (133063\* 133061\*\*)**  
Bord 200 mm brute  
Panel 200 mm mill  
Schild 200 mm roh

## 20 Bord bevestiging / Panel assembly / Schildmontage

Schroef ST 3.5 of bout M6  
Screw ST 3.5 or bolt M6  
Schrauben ST 3.5 oder Bolzen M6

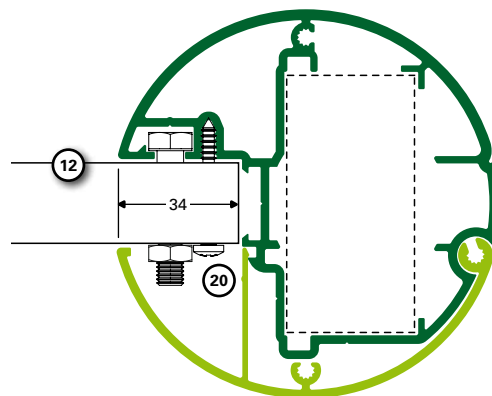

- 16 **133325 (133327\*)**  
Eindkap 100 mm [133040] brute  
End cap 100 mm [133040] mill  
Endstück 100 mm [133040] roh
- 17 **133330 (133332\*)**  
Eindkap 150 mm [133050] brute  
End cap 150 mm [133050] mill  
Endstück 150 mm [133050] roh
- 18 **133335 (133337\*)**  
Eindkap 200 mm [133060] brute  
End cap 200 mm [133060] mill  
Endstück 200 mm [133060] roh

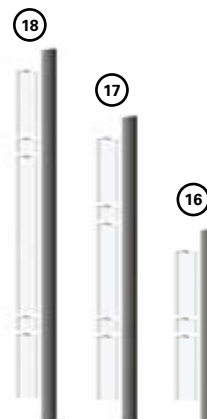

## 19 Lichtkoof / Throughlight / Leuchtelement

Met toepassing van het SlimLine lichtkoof systeem kunnen tevens enkel- of dubbelzijdig verlichte bewegwijzingen worden vervaardigd.

With SlimLine throughlight systems, single and double sided illuminated signing is also possible.

Unter Anwendung des SlimLine-Leuchtelementsystems können zudem ein- oder doppelseitig beleuchtete Ausschilderungen angefertigt werden.



# Winning | Extraction | Gewinning

**NL** Aluminium is na zuurstof en silicium het meest voorkomende element op aarde. Zo'n 8% van onze aardkroon bestaat uit aluminium, echter altijd gebonden met zuurstof als  $Al_2O_3$ . Dit komt het meeste voor in bauxiet wat gemiddeld 55% aluminiumoxide bevat. De bauxiet productie in 2011 was in totaal 220 miljoen ton, de bauxiet reserve was in 2011 totaal 27 miljard ton.

**EN** After oxygen and silicon, aluminium is the most frequently found element on earth. Some 8% of our earth's crust consists of aluminium, although this is always bound to oxygen as  $Al_2O_3$ . This is most often found in bauxite, which on average contains 55% aluminium oxide. Bauxite production in 2011 total 220 million ton. Bauxite reserve in 2011 total 27 billion ton.

**DE** Aluminium ist nach Sauerstoff und Silizium das am häufigsten vorkommende Element auf der Erde. Circa 8 % unserer Erdkruste besteht aus Aluminium, jedoch immer mit Sauerstoff als  $Al_2O_3$  gebunden. Dies kommt am meisten in Bauxit vor, welches durchschnittlich 55 % Aluminiumoxide enthält. Bauxit Produktion im 2011 Total 220 Millionen Tonnen, Bauxit Reserve im 2011 insgesamt 27 Milliarden Tonnen.

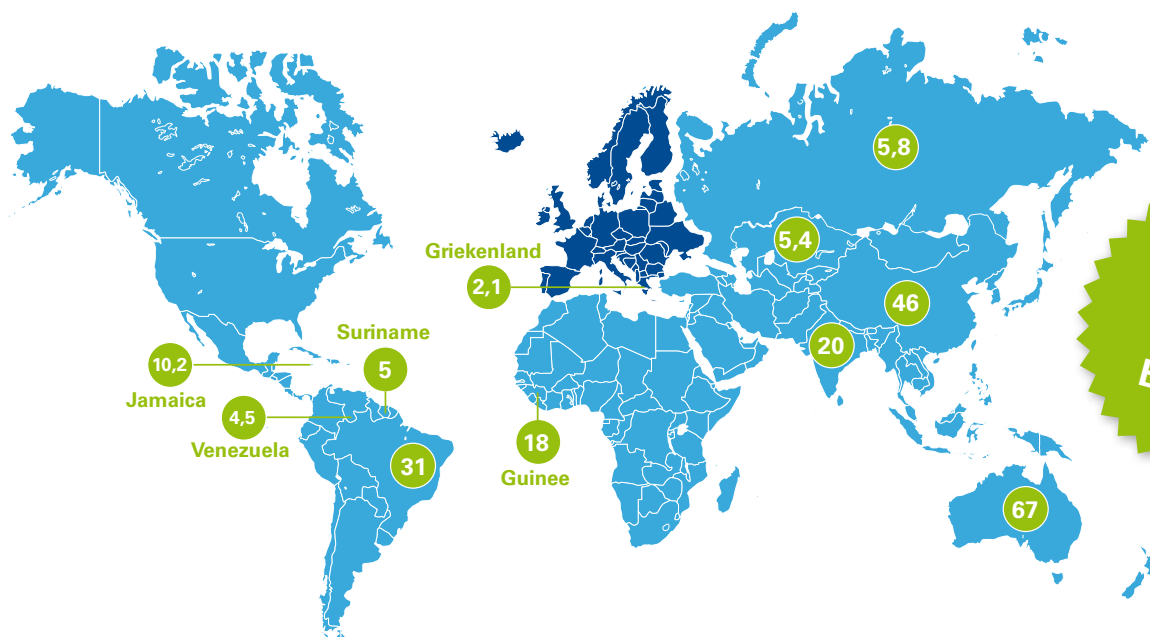
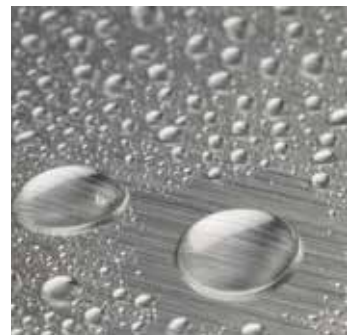

x1.000.000

**COMHAN**  
= ENERGY EFFICIENT